

GT18 Paperless Recorder

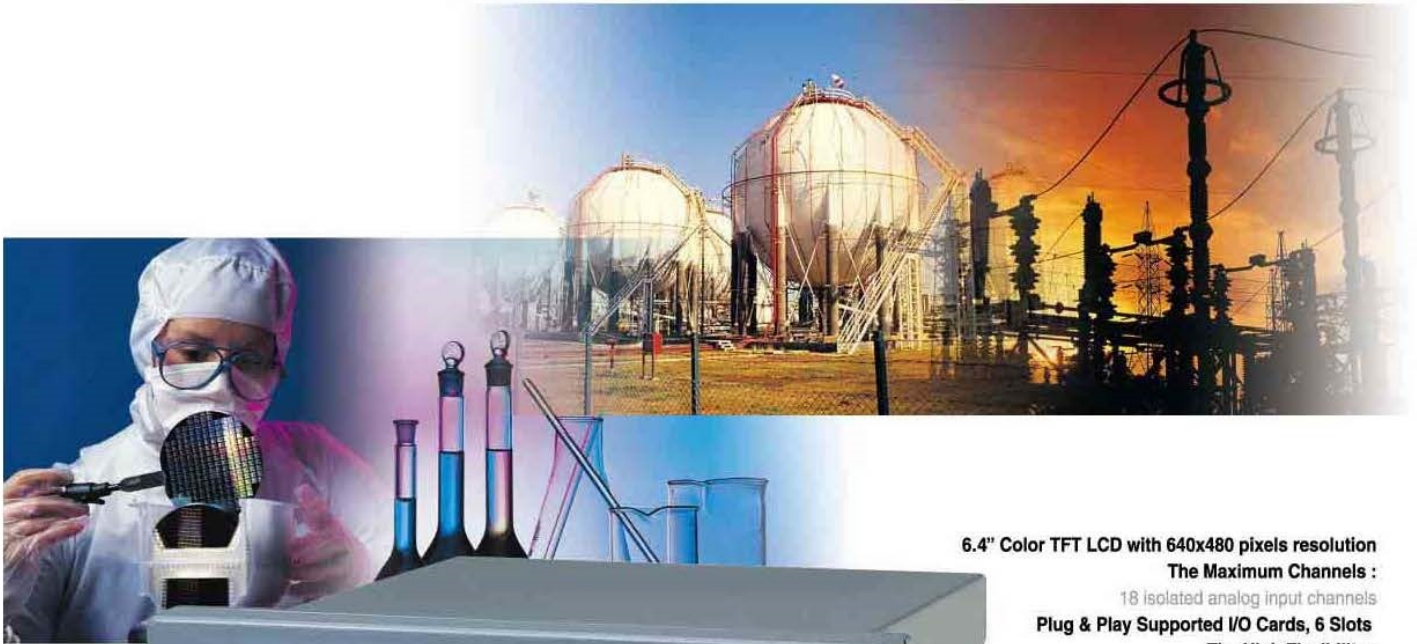

6.4" Color TFT LCD with 640x480 pixels resolution

The Maximum Channels :

18 isolated analog input channels

Plug & Play Supported I/O Cards, 6 Slots

The High Flexibility :

User configurable I/O card

Expandable modular architecture

Flexible screen configuration

User-Friendly :

Soft keys coupled with interactive dialog simplify

setup & operation procedures

Easy - to - access function keys

Infrared Detector :

Shut off LCD automatically to prolong LCD life

and save power while nobody near by

Save Space :

Only 174 mm (6.9") depth behind panel

Various Display Formats :

Vertical trend, Horizontal trend,

Bar Graph, Numerical or mixed

Save Data in Flash ROM,

Compact Flash Card or PC

Communication :

Standard Ethernet and optional RS-232/422/485

The Highest Accuracy :

18-bit A -D analog input, 15-bit D-A analog output.

Fast Sampling Rate :

Within 200 msec for all channels,

Programmable Filter or Moving Average Sampling Method

Statistics with Instant, Average, Min./Max. Values

Programmable Alarms and Messages available

Portable / Bench Top Assembly Kit available



GT18 is the World First paperless recorder of the same size with the highest resolution (true VGA , 640x480 pixels), infrared detector, 18 channels, plug & play I/O card, high flexibility, the most user - friendly and the shortest depth. In chemical plant, food & beverage plant, petrochemical plant, semiconductor plant, metal alloy, automotive plant, environmental monitoring or laboratory, VR18 can be used to monitor, record, evaluate the processes in the plants.

The user can access data on the screen as well as on site from a remote place via RS-232, RS-485, RS-422 serial interface or Ethernet networking. The historical data can be stored in flash ROM, Compact Flash Card, or collected in a remote host PC for data evaluation and print-out.

Panel Mounted Style

6.4" color TFT LCD 640x480 pixels resolution

Infrared detector protect LCD & save power



BenchTop / Portable Style



Power switch

Compact Flash Card

Portable handle

12 SOFT KEYS FOR EASY OPERATION

Rear Terminals

standard Ethernet and optional RS-232/422/485

Power supply

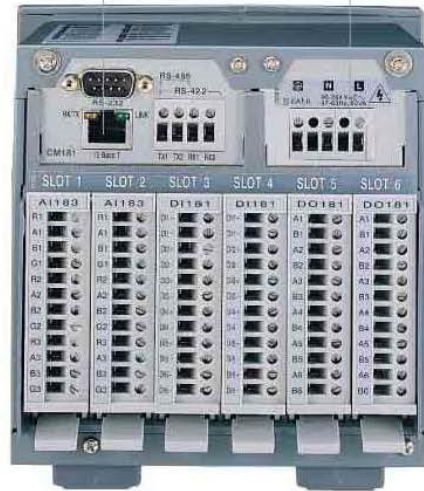

6 SLOTS for Plug & play I/O cards, maximum 18 analog input or mixed with analog & digital I/O cards

Input & Output Cards

Digital input

Digital output (6 alarms)

Analog input



Configure input by DIP switches

Mixed Mode

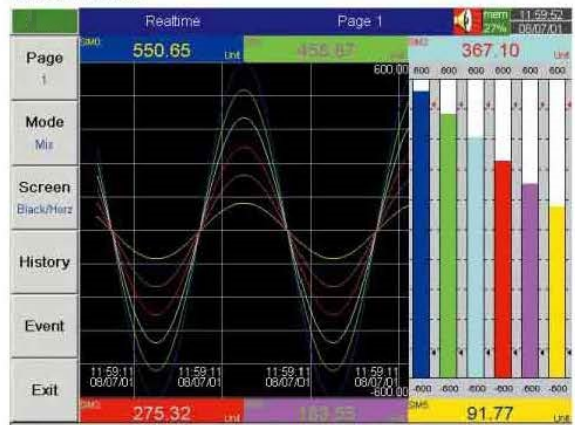

- View max. 6 mixed real time data trends horizontally.
- Display data in "Bars" and "Digits" together with mixed "Trends".
- Recognize data trends easily by different colors and tag names.
- Switch to other configured pages easily by "Page" function key.
- Display current "Time/Date" information.
- Remind the user of "Alarm" or "Memory Full".

Trend Mode

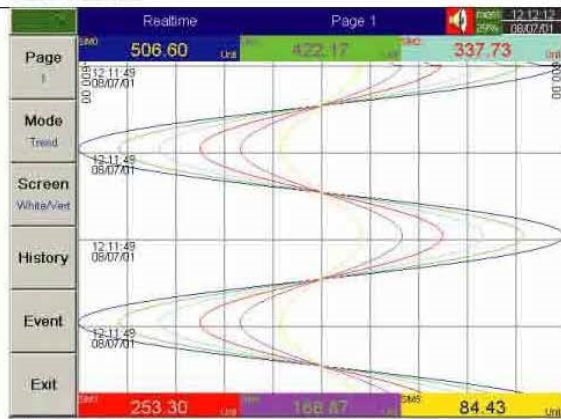

- View max. 6 real time data trends vertically.
- Recognize data trends easily by different colors and tag names.
- Switch to other configured pages easily by "Page" function key.
- Display current "Time/Date" information.
- Remind the user of "Alarm" or "Memory Full"

Bar Graph Mode

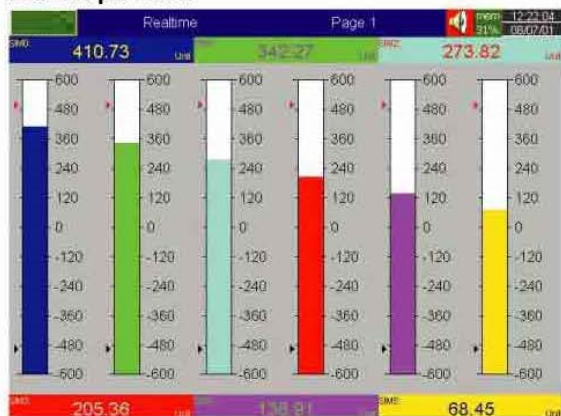

- View max. 6 real time data in bar graphs.
- Scale individually by user in "configuration".
- Display data value and tag name in different colors together with each bar graph.
- Mark "Hi/Lo" alarm limits.
- Display current "Time/Date" information.
- Remind the user of the "Alarm" or "Memory Full".

Numerical Mode



- View max. 6 real time data in numbers.
- Display data value and tag name in different color.
- Mark "Hi/Lo" alarm limits.
- Display current "Time/Date" information.
- Remind the user of the "Alarm" or "Memory Full".

Historical Mode

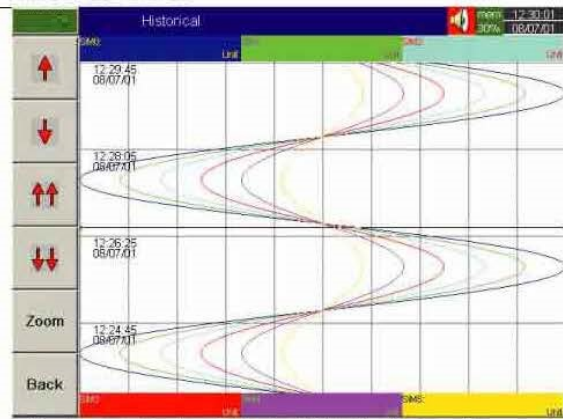

- Display max. 6 sets of historical data simultaneously.
- View desired data section by "↑&'↓" function keys.
- Access precise data value at a point selected by moving the "ruler".
- "Zoom" to expand/contract the display time span.
- View historical data trends and their respective data values.
- Recognize trends easily by different colors and individual tag names.

Alarm List

Act	Type	Source	Active Time	Clear Time	Status
3	Event	FW ON	2001/8/7 12:21:37		
4	LoAlarm	SIM6	2001/8/7 12:21:41	2001/8/7 12:25:10	Cleared
5	LoAlarm	SIM12	2001/8/7 12:21:41	2001/8/7 12:26:44	Cleared
6	LoAlarm	SIM18	2001/8/7 12:21:41	2001/8/7 12:25:6	Cleared
7	HiAlarm	SIM0	2001/8/7 12:22:12	2001/8/7 12:25:3	Cleared
8	HiAlarm	SIM0	2001/8/7 12:25:33	2001/8/7 12:29:34	Cleared
9	HiAlarm	SIM15	2001/8/7 12:25:48	2001/8/7 12:30:10	Cleared
10	HiAlarm	SIM6	2001/8/7 12:26:35	2001/8/7 12:29:11	Cleared
11	HiAlarm	SIM12	2001/8/7 12:26:45	2001/8/7 12:29:11	Cleared
12	LoAlarm	SIM12	2001/8/7 12:29:12	2001/8/7 12:31:5	Cleared
13	HiAlarm	SIM6	2001/8/7 12:29:57	2001/8/7 12:31:5	Cleared
14	LoAlarm	SIM0	2001/8/7 12:30:38	2001/8/7 12:31:5	Cleared
15	LoAlarm	SIM18	2001/8/7 12:30:52	2001/8/7 12:31:51	Cleared
16	HiAlarm	SIM12	2001/8/7 12:31:5	2001/8/7 12:31:47	Cleared
17	LoAlarm	SIM6	2001/8/7 12:31:38	2001/8/7 12:31:55	Cleared
18	LoAlarm	SIM12	2001/8/7 12:31:48	2001/8/7 12:30:27	Cleared
19	HiAlarm	SIM0	2001/8/7 12:32:16	2001/8/7 12:34:6	Cleared
20	HiAlarm	SIM18	2001/8/7 12:32:32	2001/8/7 12:34:6	Cleared
21	HiAlarm	SIM6	2001/8/7 12:33:16	2001/8/7 12:34:6	Cleared
22	HiAlarm	SIM12	2001/8/7 12:33:28	2001/8/7 12:35:7	Cleared
23	LoAlarm	SIM0	2001/8/7 12:34:6	2001/8/7 12:37:7	Cleared
24	LoAlarm	SIM18	2001/8/7 12:34:12	2001/8/7 12:37:7	Cleared
25	LoAlarm	SIM6	2001/8/7 12:34:58	2001/8/7 12:37:7	Cleared
26	LoAlarm	SIM12	2001/8/7 12:35:8	2001/8/7 12:37:7	Cleared
27	HiAlarm	SIM0	2001/8/7 12:36:18		Normal
28	LoAlarm	SIM0	2001/8/7 12:37:19		Normal

- List all the alarm records clearly with useful information.
- Browse through the alarm list or "acknowledge" alarm easily by function keys on the vertical bar.
- Remind the user of the alarm status in different colors.

Configuration Mode

1	2	3	4	5	6	7	8	9	10	11	12
Name: AI		Desc:		Method: Instant		Speed: 1.5		Offset: 0.0		Gain: 1.000	
Sensor: Thermocouple 3 Type Unit: °C Range: -120.0~1000.0											
-Event											
No	Type	Setpoint	Job 1	Job 2	Hysteresis						
1	H	776.0	Log Alarm	No Action	Off						
2	L	104.0	Log Alarm	No Action	Off						
3	HH	860.0	Log Alarm	No Action	Off						
4	LL	20.0	Log Alarm	No Action	Off						

- Configure pen (input/output, pen name, event, job.....)
- Configure page (color, pen, decimal, pen width.....)
- Configure timer.
- Configure instrument (storage media, display, communication, time/date....)

INSTALLATION

Mechanical Data

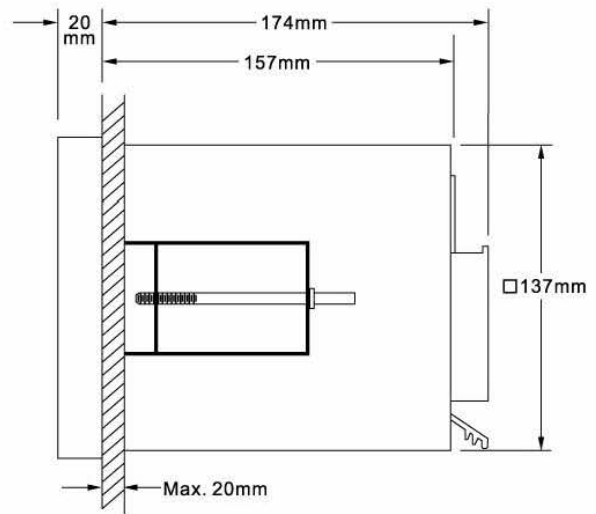
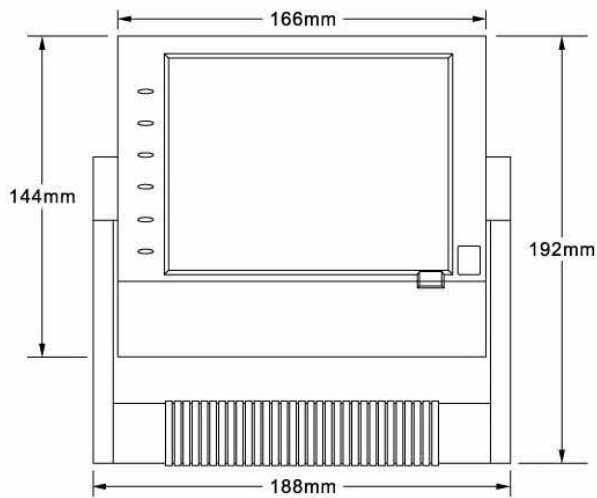

Panel Cutout

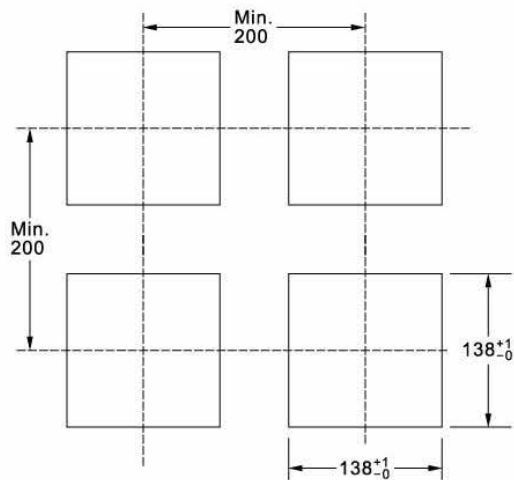

Wiring Cable

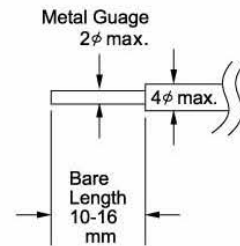

Analog Input Card (AI181, AI182, AI183)

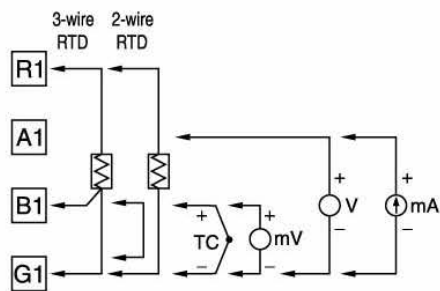

Analog Output Card (AO183I, AO183V)

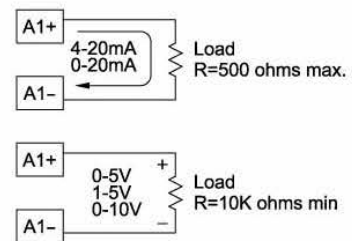

Digital Input Card (DI181)

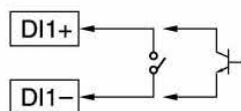

Digital Output Card (DO181)

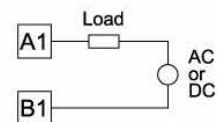

SPECIFICATIONS

Power

90-250VAC, 47-63Hz, 60VA, 30W maximum
11-18, 18-36 or 36-72 VDC 60VA, 30W maximum

Display

6.4" TFT LCD, 640X480 pixel resolution, 256 colors

Memory

Storage Memory on board: 8MB.
CF Card: 128MB standard.

Analog Input Card (AI181, AI182, AI183)

Resolution: 18 bits
Sampling Rate: 5 times/second
Maximum Rating: -2 VDC minimum, 12 VDC maximum
(1 minute for mA input)
Temperature Effect: $\pm 1.5 \mu\text{V}/^\circ\text{C}$ for all inputs except mA input
 $\pm 3.0 \mu\text{V}/^\circ\text{C}$ for mA input
Sensor Lead Resistance Effect:
T/C: $0.2 \mu\text{V}/\text{ohm}$
3-wire RTD: $2.6^\circ\text{C}/\text{ohm}$ of resistance difference of two leads
2-wire RTD: $2.6^\circ\text{C}/\text{ohm}$ of resistance sum of two leads
Burn-out Current: 200nA
Common Mode Rejection Ratio (CMRR): 120dB
Normal Mode Rejection Ratio (NMRR): 55dB
Isolation Breakdown Voltage among channels: 430VAC min.
Sensor Break Detection:
Sensor open for TC,RTD and mV inputs,
below 1 mA for 4-20mA input,
below 0.25V for 1-5V inputs,
unavailable for other inputs.
Sensor Break Responding Time:
Within 10 seconds for TC, RTD and mV inputs,
0.1 second for 4-20 mA and 1-5V inputs.

Characteristics:

Type	Range	Accuracy @25°C	Input Impedance
J	-120°C - 1000°C (-184°F - 1832°F)	$\pm 1^\circ\text{C}$	2.2MΩ
K	-200°C - 1370°C (-328°F - 2498°F)	$\pm 1^\circ\text{C}$	2.2MΩ
T	-250°C - 400°C (-418°F - 752°F)	$\pm 1^\circ\text{C}$	2.2MΩ
E	-100°C - 900°C (-148°F - 1652°F)	$\pm 1^\circ\text{C}$	2.2MΩ
B	0°C - 1820°C (32°F - 3308°F)	$\pm 2^\circ\text{C}$ (200°C - 1820°C)	2.2MΩ
R	0°C - 1767.8°C (32°F - 3214°F)	$\pm 2^\circ\text{C}$	2.2MΩ
S	0°C - 1767.8°C (32°F - 3214°F)	$\pm 2^\circ\text{C}$	2.2MΩ
N	-250°C - 1300°C (-418°F - 2372°F)	$\pm 1^\circ\text{C}$	2.2MΩ
L	-200°C - 900°C (-328°F - 1652°F)	$\pm 1^\circ\text{C}$	2.2MΩ
PT100 (DIN)	-210°C - 700°C (-346°F - 1292°F)	$\pm 0.4^\circ\text{C}$	1.3KΩ
PT100 (JIS)	-200°C - 600°C (-328°F - 1112°F)	$\pm 0.4^\circ\text{C}$	1.3KΩ
mV	-8mV - 70mV	$\pm 0.05\%$	2.2MΩ
mA	-3mA - 27mA	$\pm 0.05\%$	70.5Ω
0~1V	-0.12 - 1.15V	$\pm 0.05\%$	32KΩ
0~5V	-1.3V - 11.5V	$\pm 0.05\%$	332KΩ
1~5V	-1.3V - 11.5V	$\pm 0.05\%$	332KΩ
0~10V	-1.3V - 11.5V	$\pm 0.05\%$	332KΩ

Analog Input Card (AI183V)

Type	Range	Accuracy @25°C	Input Impedance
-60~60mV	-62~62mV	$\pm 0.1\%$	2.2MΩ
-2~2V	-2.2~2.2V	$\pm 0.3\%$	332KΩ
-20~20V	-22~22V	$\pm 0.1\%$	332KΩ
-20~20mA	-22~22mA	$\pm 0.1\%$	70.5Ω

Digital Input Card (DI181)

Channels: 6 per card
Logic Low: -5V minimum, 0.8V maximum.
Logic High: 2V minimum, 5V maximum
External Pull-down Resistance: 1KΩ maximum
External pull-up Resistance: 1.5MΩ minimum

Digital Output Card (DO181)

Channels: 6 per card
Contact Form: N.O. (form A) .
Relay Rating: 5A/240 VAC, life cycles 200,000 for resistive load.

Analog Output Card (AO183I, AO183V)

Output Signal : 4-20mA, 0-20mA (AO183I)
0-5V, 1-5V, 0-10V (AO183V)
Resolution : 15 bits
Accuracy: $\pm 0.05\%$ of Span $\pm 0.0025\% / ^\circ\text{C}$
Load Resistance: 0-500 ohms (for current output)
10K ohms minimum (for voltage output)
Output Regulation: 0.01% for full load change
Output Setting Time: 0.1 sec (stable to 99.9 %)
Isolation Breakdown Voltage: 1000VAC min.
Integral Linearity Error: $\pm 0.005\%$ of Span
Temperature Effect: $\pm 0.0025\%$ of Span / $^\circ\text{C}$

COMM Module (CM181)

Interface: RS-232 (1 unit), RS-485 or RS-422 (up to 247 units)
Protocol: Modbus Protocol RTU mode
Address: 1-247
Baud Rate: 0.3~38.4 Kbits/sec.
Data Bits: 7 or 8 bits
Parity Bit: None, Even or Odd
Stop Bit: 1 or 2 bits

Standard Ethernet Communication

Protocol: Mod Bus TCP / IP, 10 BaseT
Auto polarity correction for 10 BaseT
Ports: RJ-45

Infrared Detector

Distance: Detect moving human body within 2 meters

Environmental & Physical

Operating Temperature: 5°C to 50°C
Storage Temperature: -25°C to 60°C
Humidity: 20 to 80% RH (non-condensing)
Insulation Resistance: 20 Mohms min. (at 500 VDC)
Dielectric Strength: 1350VAC 50/60 Hz for 1 minute
Vibration Resistance: 10-55 Hz, 10m/S² for 2 hours
Shock Resistance: 30 m/S² (3g) for operation, 100g for transportation
Dimensions: 166mm(W) x 144mm(H) x 174mm(D) for panel mount

Approval Standards

Safety: UL61010 C-1
CSA C22.2 No. 24-93
CE: EN61010-1 (IEC1010-1)
Overvoltage category II, Pollution degree 2

Protective Class:

IP 30 front panel, indoor use,
IP 20 housing and terminals

EMC

Emission: EN50081-1, EN61326
(EN55011 class A,
EN61000-3-2, EN61000-3-3)
Immunity: EN50082-2, EN61326
(EN61000-4-2, EN61000-4-3,
EN61000-4-4, EN61000-4-5,
EN61000-4-6, EN61000-4-8,
EN61000-4-11)

ACCESSORIES LIST

Part No.	Description
AI181	1-channel analog input card (Universal except -mA, -V)
AI182	2-channel analog input card
AI183	3-channel analog input card
AI183V	3-channel analog input card (±mA, ±V only)
DI181	6-channel digital input card
DO181	6-channel relay output card
AP181	24VDC auxiliary power supply
CM181	RS-232/422/485 & Ethernet Comm module
CM182	Ethernet Comm module
PM181	90~250 VAC power supply
PM182	11-18 VDC power supply
PM183	18-36 VDC power supply
PM184	90~250 VAC power supply with power plug
PM185	36-72 VDC power supply
MK181	Panel mount assembly kit
MK183	Portable handle/bench top assembly kit
CF128	128MB compact flash card
CF512	512MB compact flash card
CF102	1GB compact flash card
AS181	Basic PC software Observer I
AS182	Extensive PC software Observer II
SC181	Slot cover for empty slot
AO183I	3-channel analog output card with current output
AO183V	3-channel analog output card with voltage output
BT181	Boot ROM w/o Math, Counter, Totalizer & FDA 21 CFR part11
BT182	Boot ROM w/ Math, Counter, Totalizer & FDA 21 CFR part11
SNA-10A	RS-485 to RS-232 converter
UMVR181	User Manual

Ordering Code:

GT18 - - -

Power

- 4: 90-250 VAC, 47-63Hz
- 5: 20-28VAC, 47-63Hz
- 6: 11-18VDC
- 7: 18-36VDC
- 8: 36-72VDC

Analog input card

- 0: none
 - 1: 1 channel with AI181
 - 2: 2 channels with AI182
 - 3: 3 channels with AI183
 - 4: 4 channels with AI181 & AI183
 - 5: 5 channels with AI182 & AI183
 - 6: 6 channels with AI183
 - A: 9 channels with AI183
 - B: 12 channels with AI183
 - C: 15 channels with AI183
 - D: 18 channels with AI183
 - G: 3 channels with AI183V
 - H: 6 channels with AI183V
 - J: 9 channels with AI183V
 - K: 12 channels with AI183V
 - L: 15 channels with AI183V
 - M: 18 channels with AI183V
- *See AI181/2/3 (V) to the left.

Digital input card

- 0: none
- 1: 6 channels
- 2: 12 channels
- 3: 18 channels
- 4: 24 channels
- 5: 30 channels
- 6: 36 channels

Digital output card

- 0: none
- 1: 6 relays
- 2: 12 relays
- 3: 18 relays
- 4: 24 relays

Communication

- 0: standard Ethernet interface
- 1: RS-232/422/485 (three in one)+Ethernet interface
- 9: special order

PC software

- 1: free basic software Observer I for non-communication application
- 2: extensive software Observer II for RS-232/422/485 or Ethernet

Firmware

- 0: basic Function
- 1: with Mathematics, Counter , Totalizer & FDA 21 CFR part 11 compliance

Storage media

- 1: 128 MB compact flash card
- 5: 512 MB compact flash card
- 6: 1GB compact flash card
- X: other options

Case / Mounting

- 1: standard panel mounting in grey case
- 2: bench top / portable style with handle, power cable for USA, in grey case
- 3: bench top / portable style with handle, power cable for Europe, in grey case
- 4: standard panel mounting in black case
- 5: bench top / portable style with handle, power cable for USA, in black case
- 6: bench top / portable style with handle, power cable for Europe, in black case

Special option

- 0: none
- 1: 24VDC auxiliary power supply (for transmitter, 6 channels)
- 2: 3-channel current output
- 3: 6-channel current output
- 4: 9-channel current output
- D: 3-channel voltage output
- E: 6-channel voltage output
- F: 9-channel voltage output
- 5: panel mounting with rear power plug
- 6: panel mounting with front power switch
- 7: 7=1+5, 24VDC auxiliary power supply with rear power plug
- 8: 8=1+6, 24VDC auxiliary power supply with front power switch
- 9: 9=1+5+6, 24VDC auxiliary power supply with rear power plug and front power switch
- X: other options

Note: * Standard model without option VR18-4X00-010-110

* The rear slots of the recorder will only accept up to 6 optional cards in any combination.